



POSSIBLE DOOR OPTIONS

There are currently six different door options that can be selected for the PEGASOS® car lift.

	Revolving door	Rolling shutter in the shaft head	Rolling shutter in the wall reveal	Ceiling hinge gate	Sectional door	Electric sliding door**
Door options						
Ground floor	✓	✗	✓	✓	✗	✓
Middle floors	✓	✗	✓	✓	✗	✓
Top floor (Shaft head)	✓	✓	✓	✗	✓	✓
Combined with other doors	✗	✓	✓	✓	✓	✗
Fire protection	✓	✗	✗	✗	✗	✗
Operation	Manual	Automatic Fully automatic				
Colour	RAL-Classic colours with surcharge					
Niche required	90 mm	52 mm	✗	✗	125 mm	90 mm
Silence Package III*	✗	✓	✓	✗	✗	✗
Shaft head with SPI (min.)*	2.550 mm	2.650 mm	2.550 mm	✗	2.790 mm	2.550 mm
Shaft head with SPII (min.)*	2.700 mm	2.700 mm	2.700 mm	✗	2.960 mm	2.700 mm
Shaft width with silence package*	Shaft width +50 mm (25 mm per side)			Shaft width is always cabin width + 600 mm (300 mm per side)		

*Silence package available on request

** Min. 200 mm wall depth for niche installation

✓ = possible ✗ = not possible

On the following pages, the essential differences and properties of the individual door variants are explained using installation examples and technical illustrations. In general, the goals should be protected from the elements when used outdoors.

The Silence Package I is included in the configurator and can be selected as an option. The two Silence Packages II & III are easily available on request. If the topic of noise protection is very important to your planning, we will be happy to advise

you in order to select the right Silence package for your building project.

If you have further questions about the door options or general questions, please use the comment field of the configurator when specifying your customer data. Our sales department will then contact you as soon as possible to discuss details of your PEGASOS® car lift.



REVOLVING DOORS

The installation of hinged doors is possible on every level. However, a combination with other door options is not possible. Hinged doors are manually operated. These are available in two fire protection classes: E120 EW60 and E120 EW30, as

well as various colours. Revolving doors for the PEGASOS® car lift are always double-wing, due to the platform size and the resulting clear door widths.

Two stop lift with hinged doors:

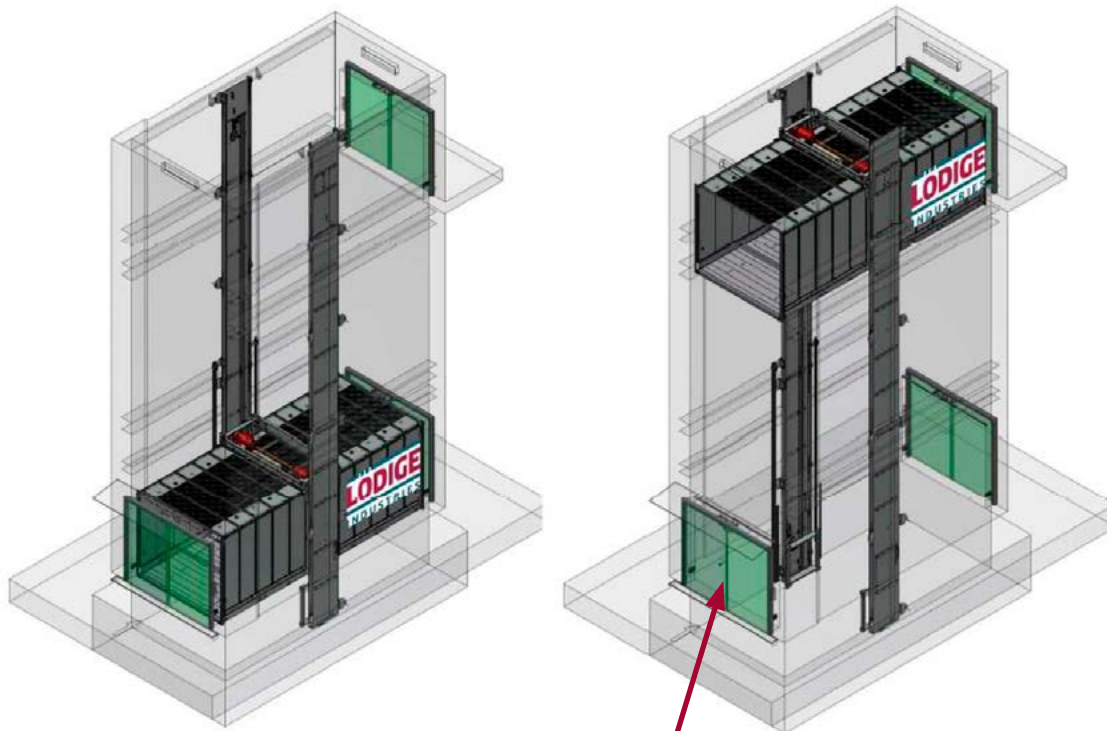

Double wing revolving doors





REVOLVING DOORS

A niche is needed in the upper and lower door area for the installation of revolving doors in the wall shaft. In the upper door area it is 90 mm and in the lower door area 100 mm wide. In the upper and side door area, the door frame is installed in the masonry. In the lower area of the door, the threshold is installed or anchored in the masonry with the help of a threshold angle.

DOOR FORMWORK

- The connecting joint between the door frame and the adjoining on-site shaft wall (door reveal) must be completely closed after installation on site and tightly sealed in accordance with the locally applicable building regulations and the specifications of the manufacturer of the fire doors in order to comply with the requirements of EN 81-58.
- The same applies to the gap between the threshold and the adjacent on-site ceiling. The overpass load must be taken into account when selecting the material.
- The door frame must be fastened on both sides by three fastening straps on the shaft wall.
- The dimensions marked with x must not be exceeded. Only then are the doors compliant with EN 81-58.

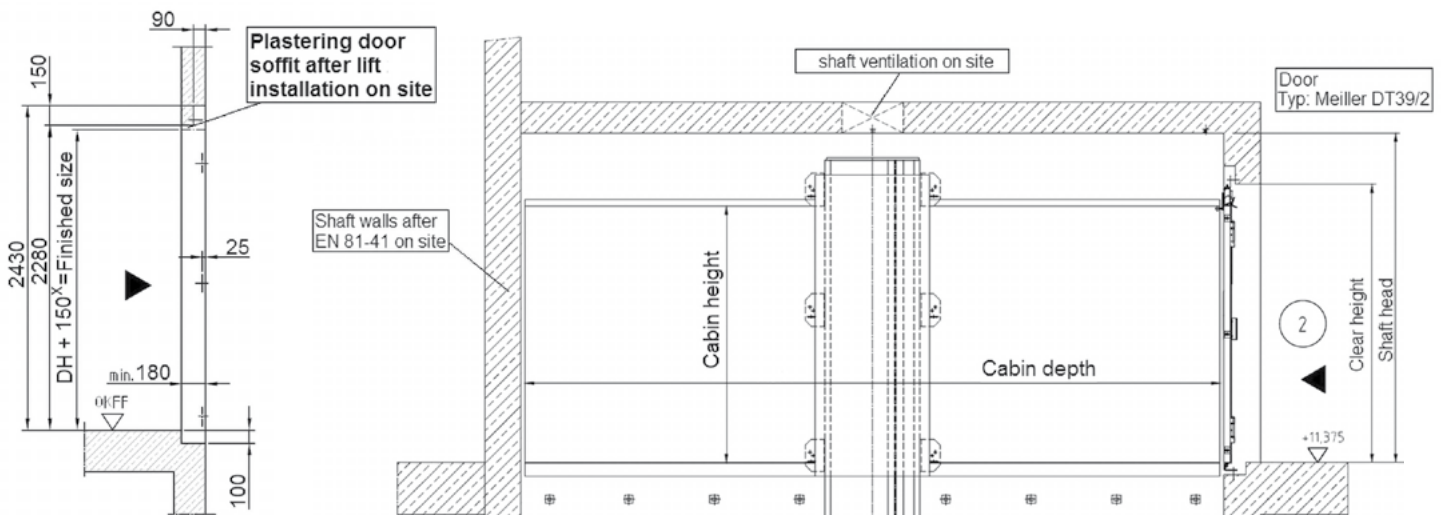
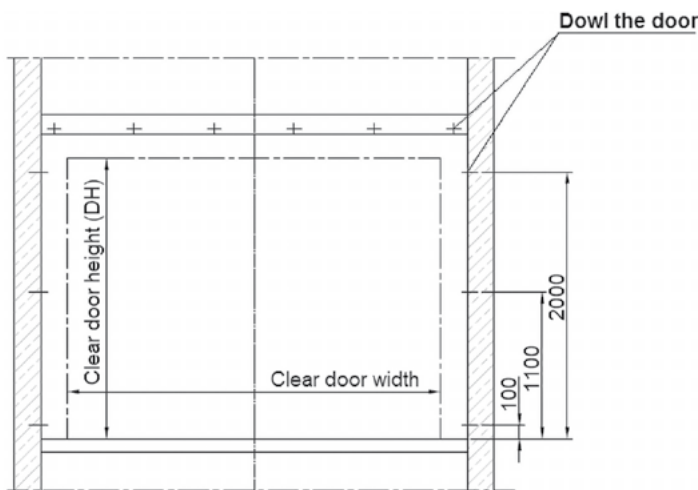
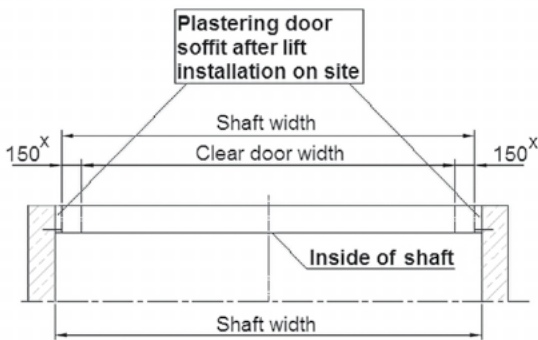



ROLLING SHUTTER IN THE SHAFT HEAD

By installing a roller door in the shaft head of the PEGASOS® car lift, additional cladding of the roller curtain and an enlarged door opening can be dispensed with. This creates the appearance of a conventional garage. For this door variant, a niche of 52 mm is required in the shaft head in the area of the roller door. This is illustrated in the figure below.

Opening and closing can be done completely automatically. An HPU75 profile is used as the standard lamella, see figure on the right. Other colors for the door sections are possible upon customer request. The RAL Classic colors are available for this. According to the manufacturer, the HPU75 profile has a heat transfer coefficient of $5 \text{ W} / (\text{m}^2 \cdot \text{K})$.

If the topic of sound insulation is a particular focus for you, or rooms in need of protection are directly adjacent to the elevator shaft, we can offer you a sound insulation package for this door variant (Silence Package III). Package III includes vibration-damping Sylomer elements that have been specially developed for use with our roller shutters, which are arranged between the drive unit of the roller shutters and the fastening elements on the building. The elements reduce the structure-borne noise from the rolling gates that are in operation and reduce airborne noise emissions in the rooms adjacent to the elevator shaft. With our reference systems we were able to reduce the airborne noise in the adjoining rooms by approx. 3 - 5 dB (A) (depending on the building structure).

As an alternative, a perforated H62 profile can be used. With the help of the H62 profile, the required shaft ventilation can be implemented at the same time. It should be noted that the H62 profile has a low soundproofing effect.



Rolling shutter in shaft head Niche 52mm

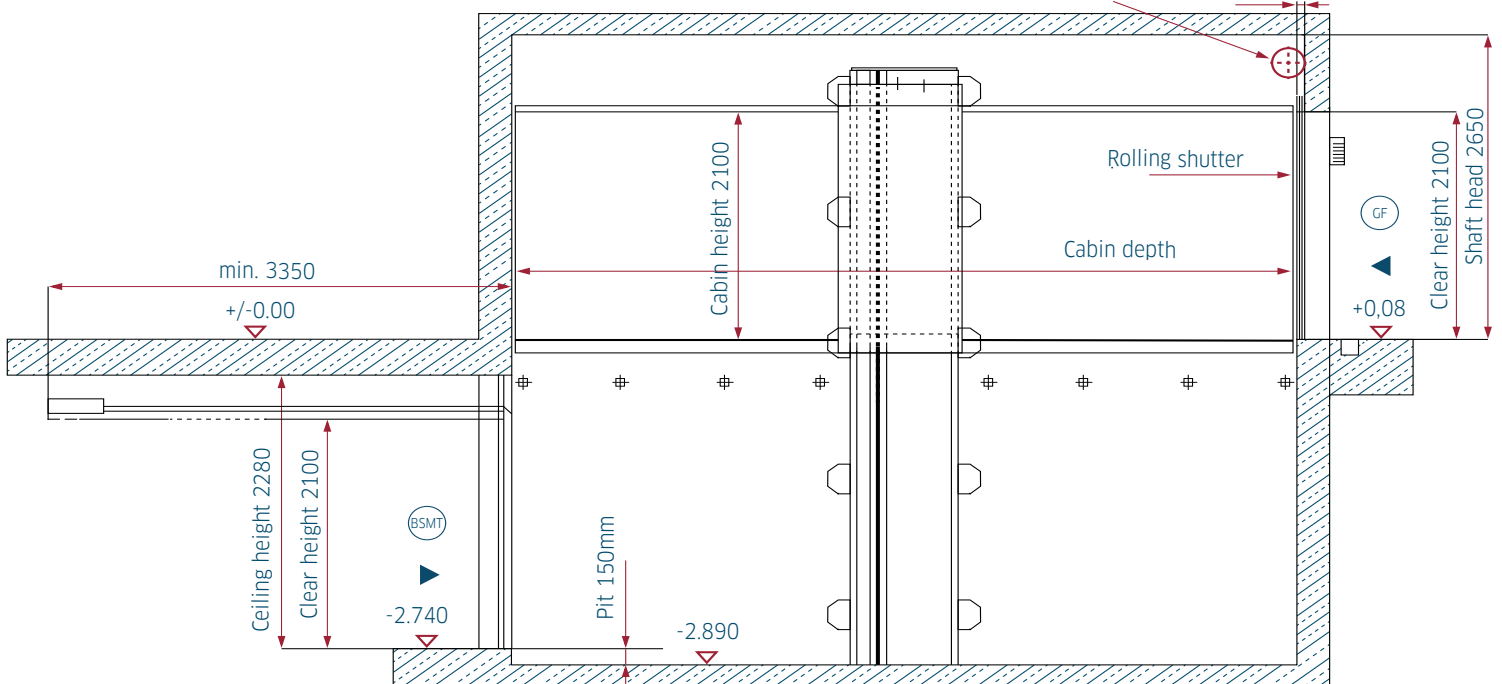



ROLLING SHUTTER IN THE SHAFT HEAD

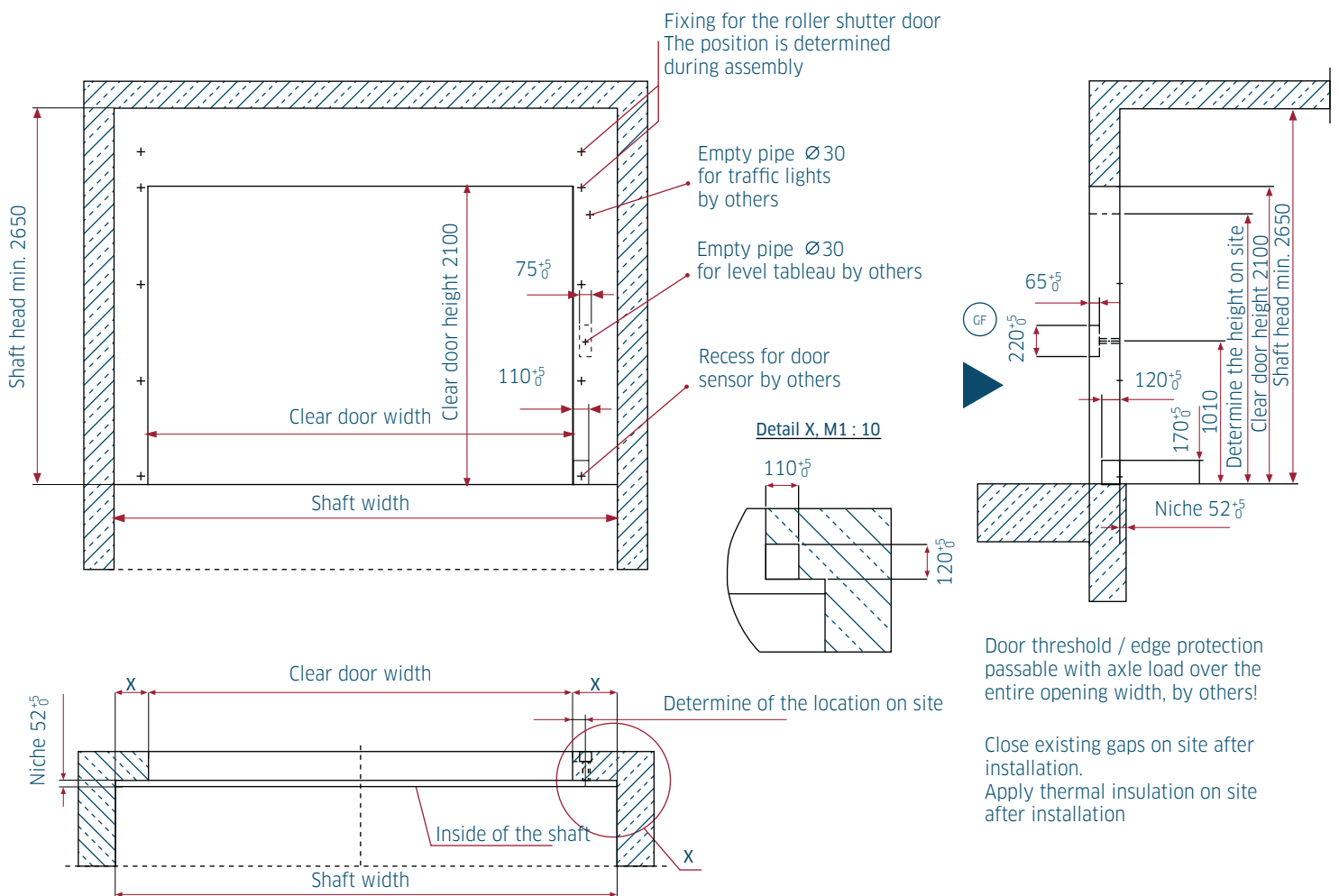



ROLLING SHUTTER IN THE WALL REVEAL

The roller shutter with roller curtain in the wall reveal can be used without restrictions on every floor. The outer cladding (roller curtain) of the roller shutter is galvanized as standard. At the customer's request, painting in all RAL Classic colors in the roller door color is possible at an additional cost.

Opening and closing can be done completely automatically. An HPU75 profile is used as the standard lamella, see figure on the right. Other colors for the door sections are possible upon customer request. The RAL Classic colors are available for this. According to the manufacturer, the HPU75 profile has a heat transfer coefficient of $5 \text{ W} / (\text{m}^2 \cdot \text{K})$.

If the roller shutter is used outdoors, this is provided by the customer to protect against weather influences (roofing or similar).

If the topic of sound insulation is a particular focus for you, or rooms in need of protection are directly adjacent to the elevator shaft, we can offer you a sound insulation package for this door variant (Silence Package III). Package III includes vibration-damping Sylomer elements that have been specially developed for use with our roller shutters, which are arranged between the drive unit of the roller shutters and the fastening elements on the building. The elements reduce the structure-borne noise from the rolling gates that are in operation and reduce airborne noise emissions in the rooms adjacent to the elevator shaft. With our reference systems we were able to reduce the airborne noise in the adjoining rooms by approx. 3 - 5 dB (A) (depending on the building structure).

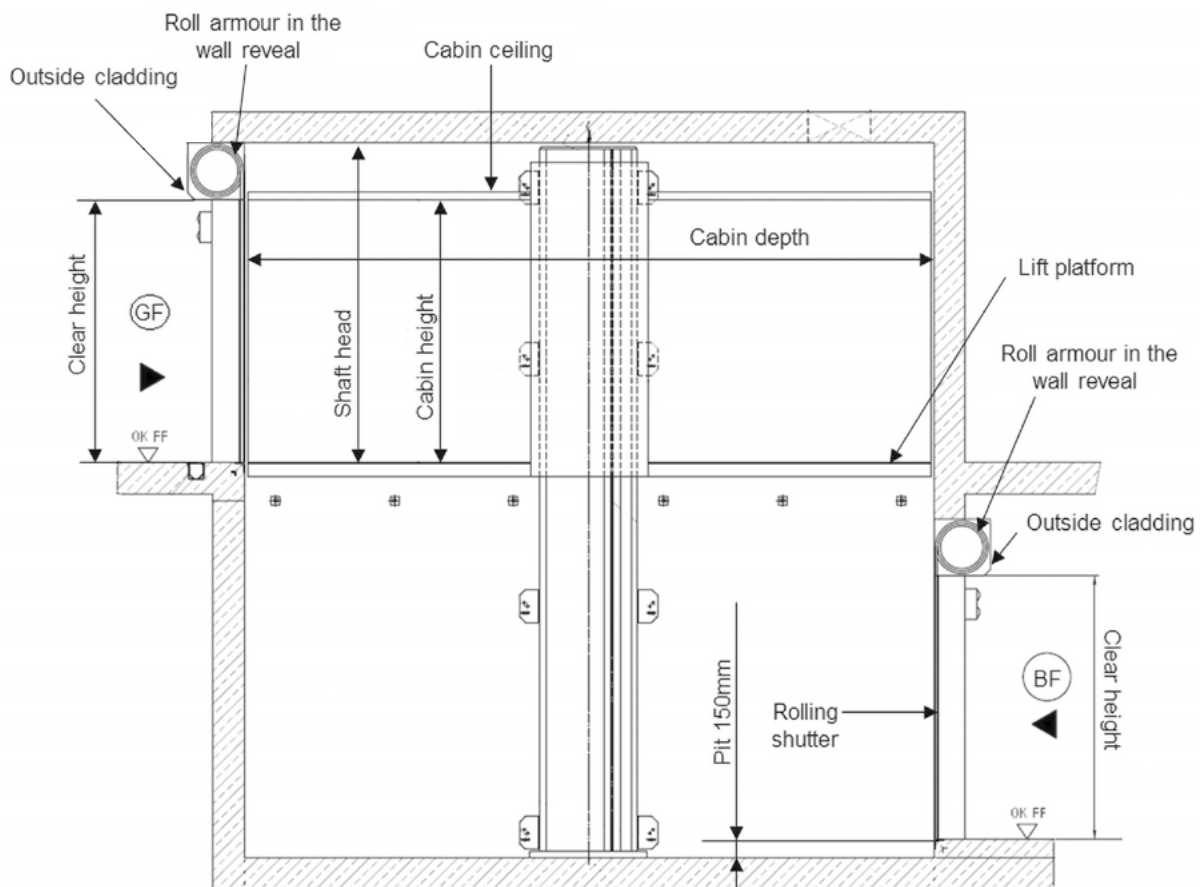
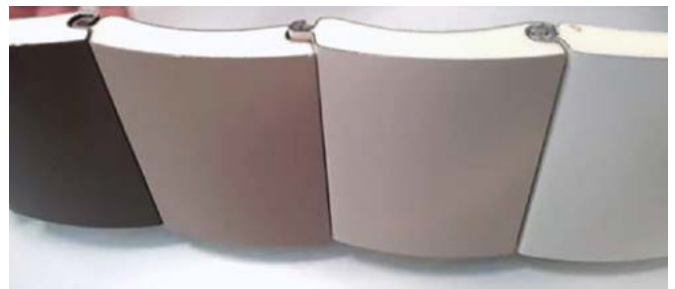



ROLLING SHUTTER IN THE WALL REVEAL

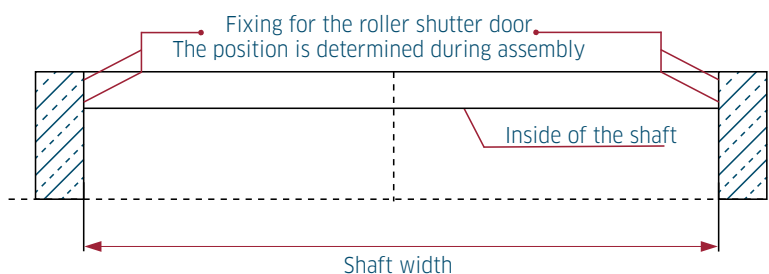
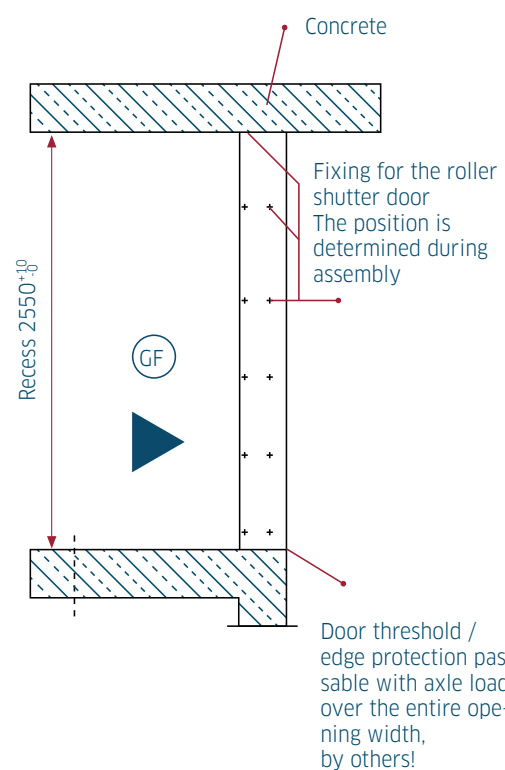
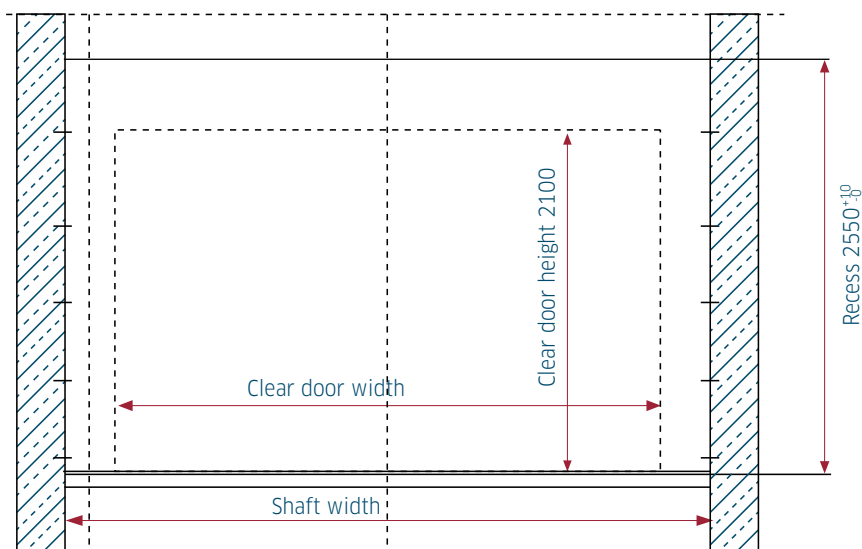

Close existing gaps on site after installation.
Apply thermal insulation on site after installation



CEILING HINGE GATE

The installation of a ceiling hinge gate is possible on every level, however, a storey ceiling is required for the attachment of the guide rails and the drive. Therefore, this door option is typically used in the lower and middle stops. The ceiling hinged gate assimilates an automatic garage door.

The drive unit and guide rails of the ceiling hinged door project below at least 3550 mm along the ceiling. The clear height of the door is always equal to the cabin height of 2100 mm. The total height of the door in the wall reveal is always 2100 mm + 180 mm.

The opening and closing can be completely automatic. All RAL-Classic colours, except metallic ones, are available. The standard door slat is an HPU75 profile, see picture on the right. Fire protection can not be realised for this door option. According to the manufacturer, the HPU75 profile has a heat transfer coefficient of $5 \text{ W} / (\text{m}^2 \cdot \text{K})$.

The ceiling hinge gate is especially suitable for low ceilings under 2550 mm in height.

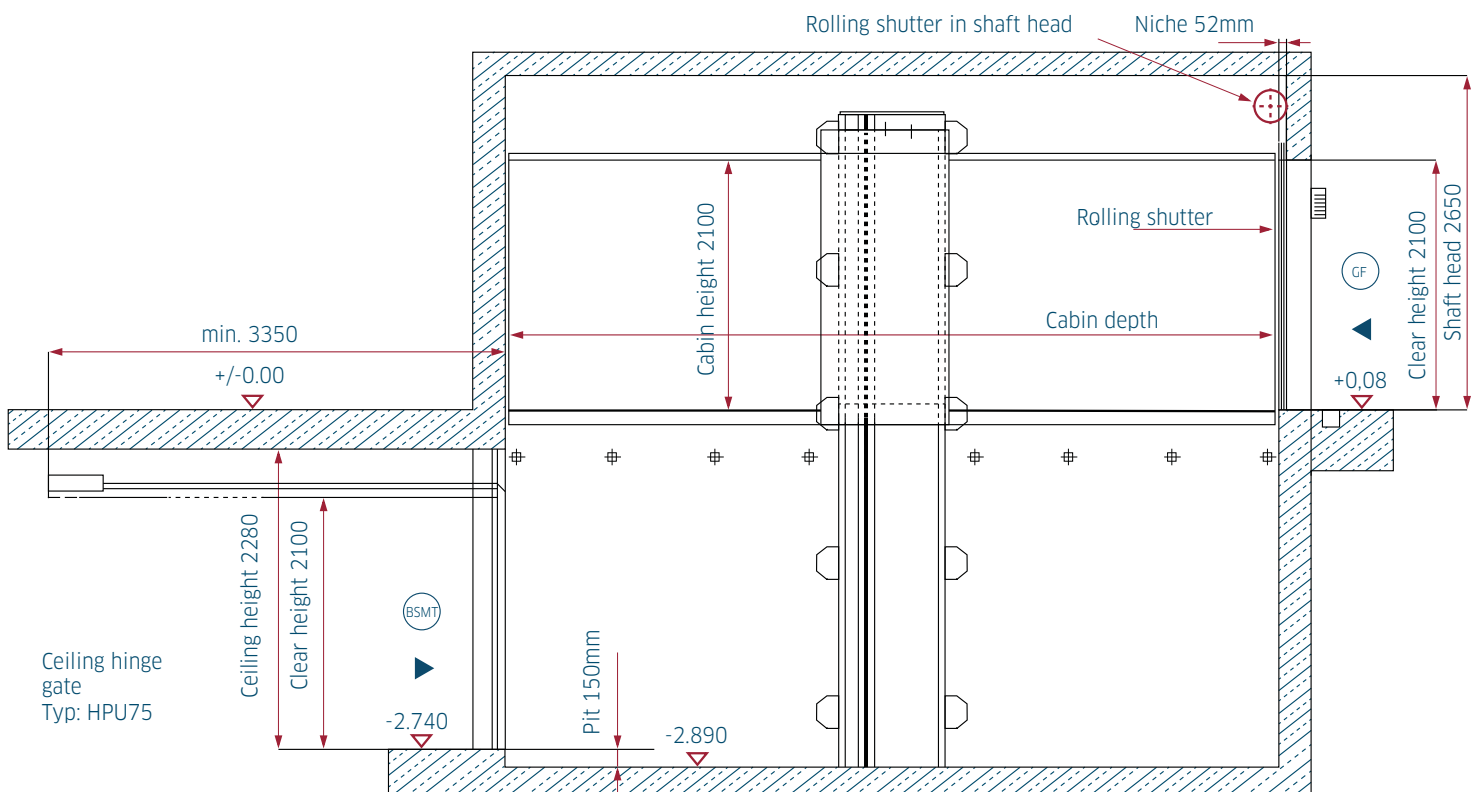



CEILING HINGE GATE

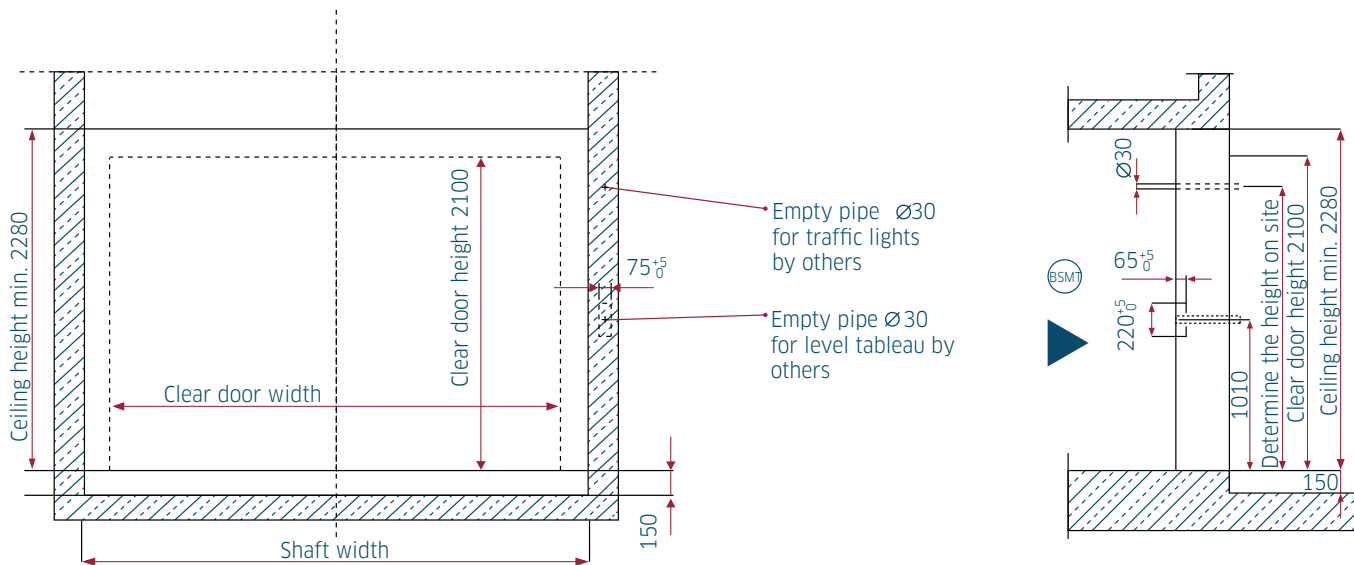

Door / edge protection passable with axle load over the entire opening width, by others!

Close existing gaps on site after installation. Apply thermal insulation on site after installation

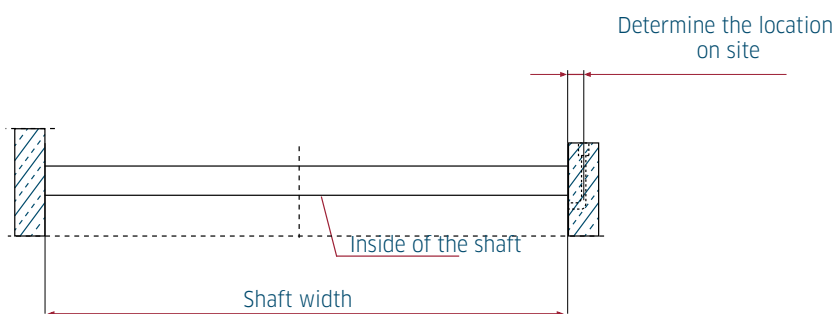



SECTIONAL DOOR

The sectional door can only be installed on the top floor of the car lift. The door is placed on the inside of the shaft directly in the area of the shaft head. A double-walled profile (LPU42) with a thickness of 42 mm is used as an L-bead on the sectional door and therefore offers good insulation. The outside of the LPU42 is available in all RAL Classic colors. The inside is made in RAL9002 as standard. Alternatively, the surface of the L-bead can be designed with decors. Simply speak to our sales colleague who is responsible for you. According to the manufacturer, the LPU42 profile has a heat transfer coefficient of $1,4 \text{ W} / (\text{m}^2 \cdot \text{K})$ and a sound insulation value of 25 dB.

As with the other roller doors, the gate is opened and closed automatically after the elevator has been called or has reached the desired destination. The sectional door can be combined with all other roller doors. However, fire protection cannot be implemented for this door variant.

In the example shown on the right, the area above the door is a special solution due to the shaft ventilation and integrated traffic light system.

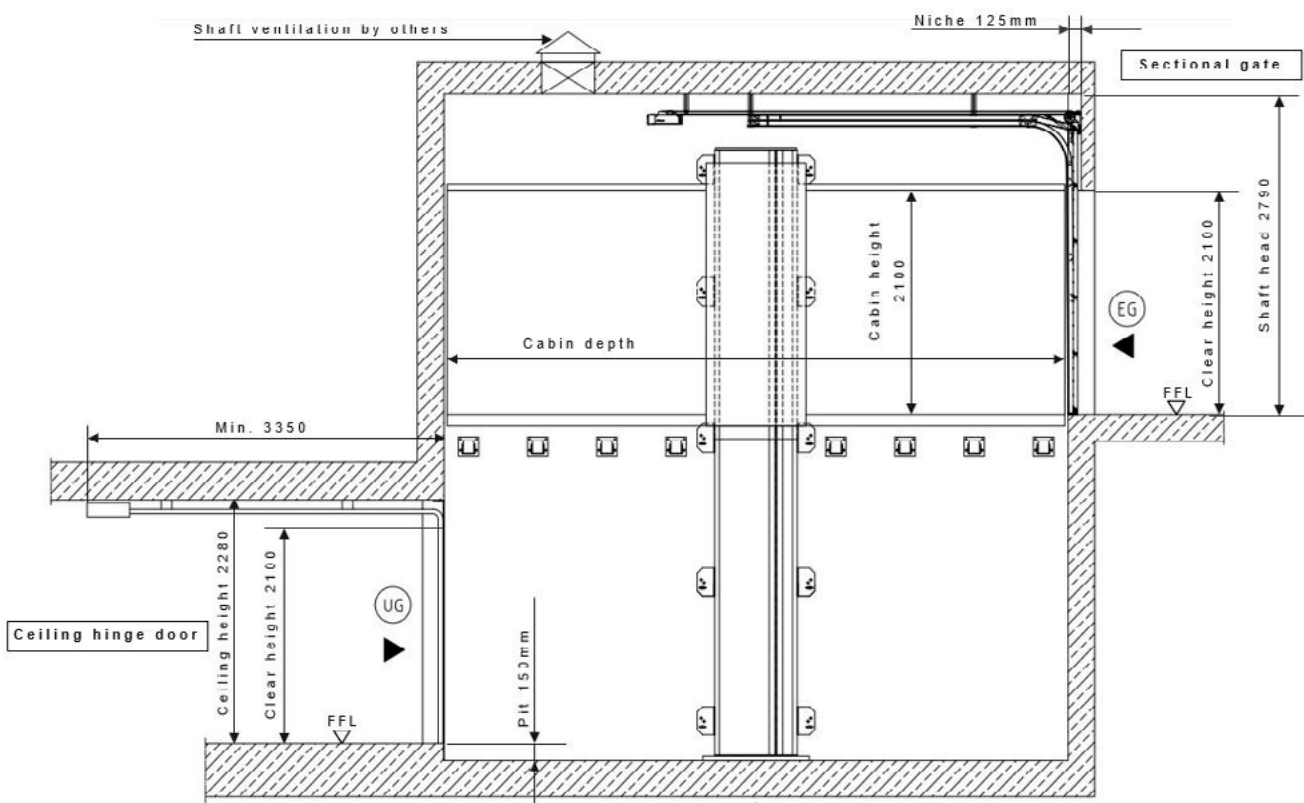



ELECTRIC SLIDING DOOR

Electric sliding doors can be installed on every level and comply with all relevant lift standards and regulations.

For the use of electric sliding doors, a minimally larger shaft width is necessary to allow the door to run laterally past the cabin into the elevator shaft. The width of the shaft when using an electric sliding door increases by 200 mm. So the full shaft width is the cabin width + 600 mm. Furthermore, a niche of at least 90 mm depth in the door and door threshold area is required. The door is microprocessor controlled and equipped with a controlled door drive and door lock according to elevator standard EN 81-20. The door opens centrally, so that shorter closing and opening times can be achieved compared to rolling shutter doors.

Fire protection is not possible with this door option. The standard surface is powder-coated according to RAL 9006. Other RAL-Classic-colours are available.

The advantages of electric sliding doors are: Smooth running, robustness and a fast opening and closing process.

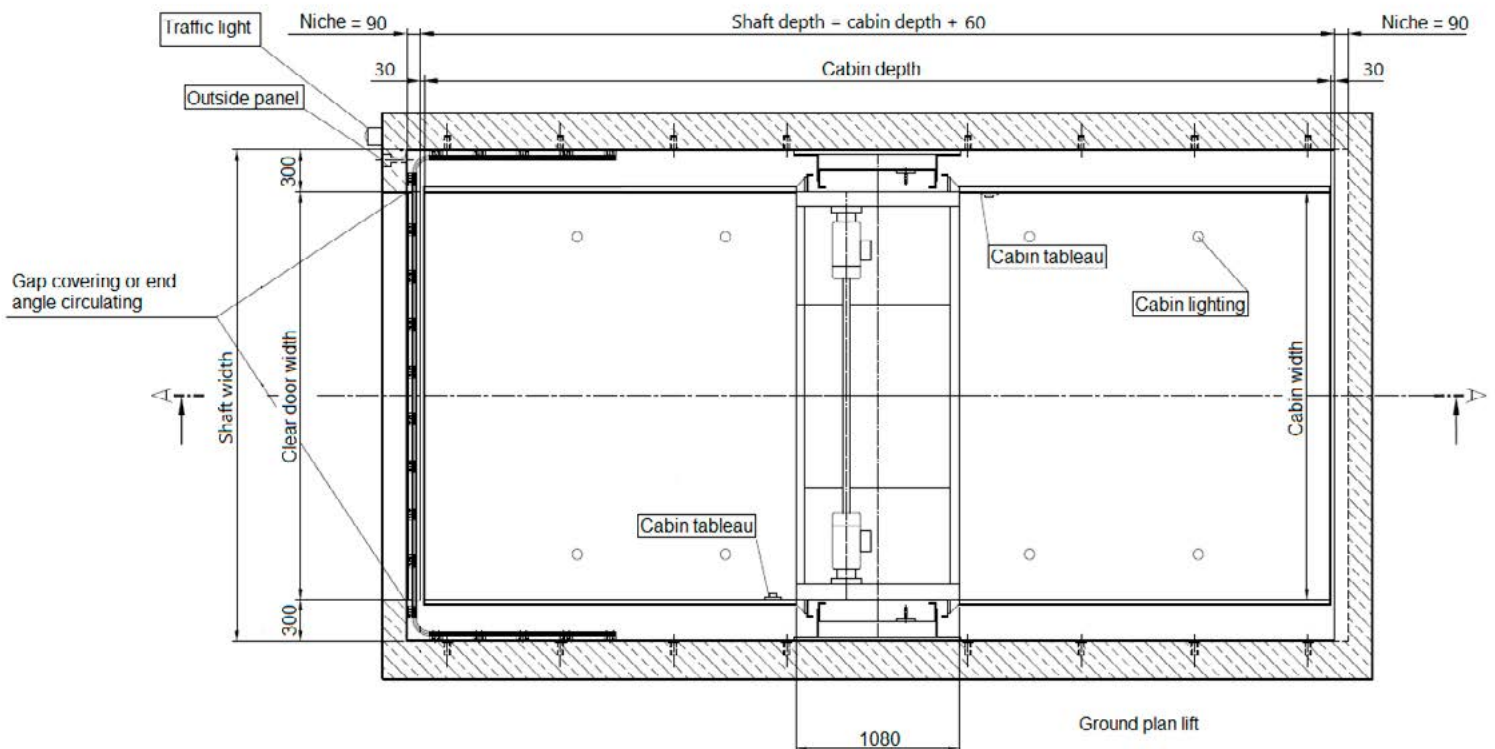



ELECTRIC SLIDING DOOR

Sideview:

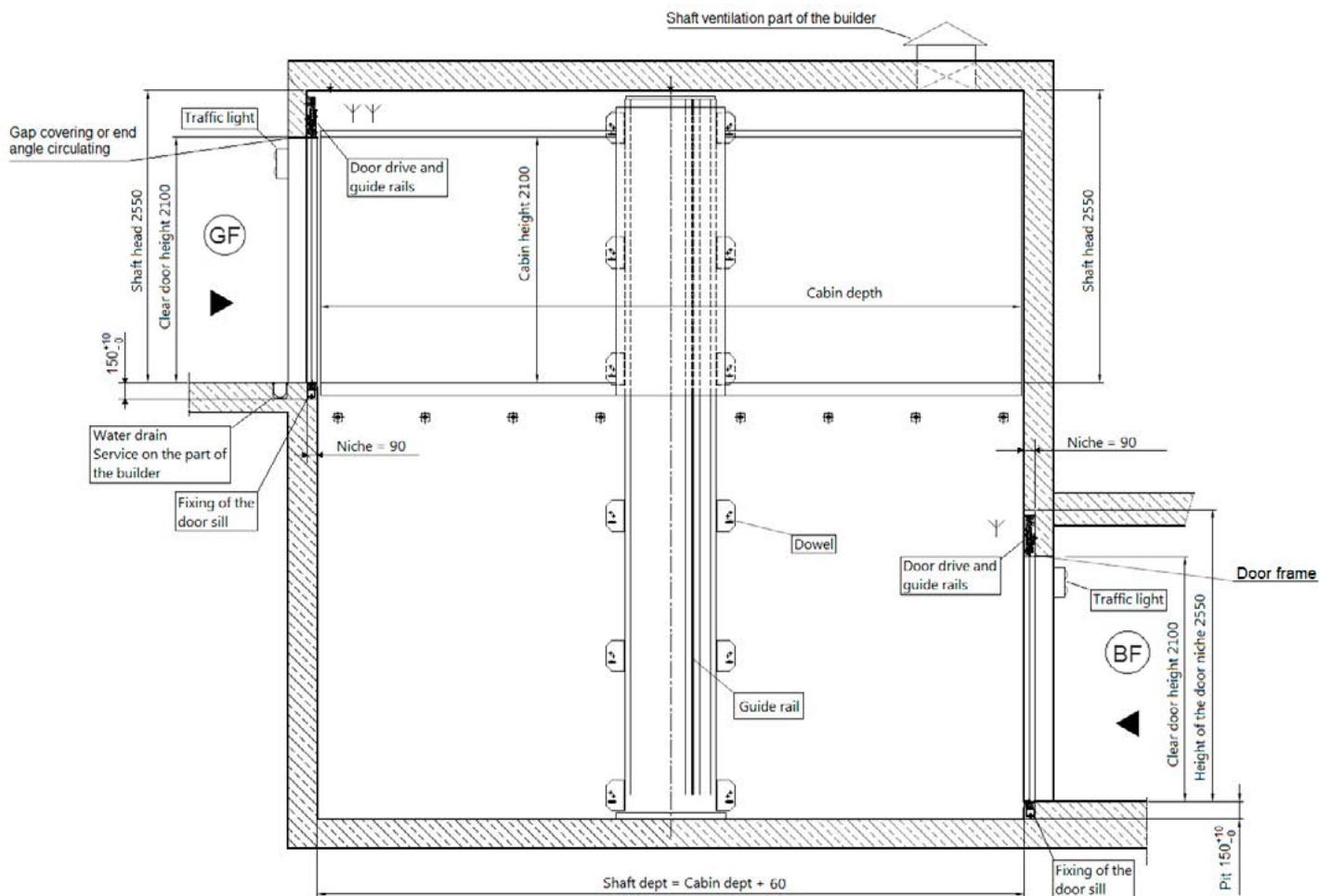



ELECTRIC SLIDING DOOR

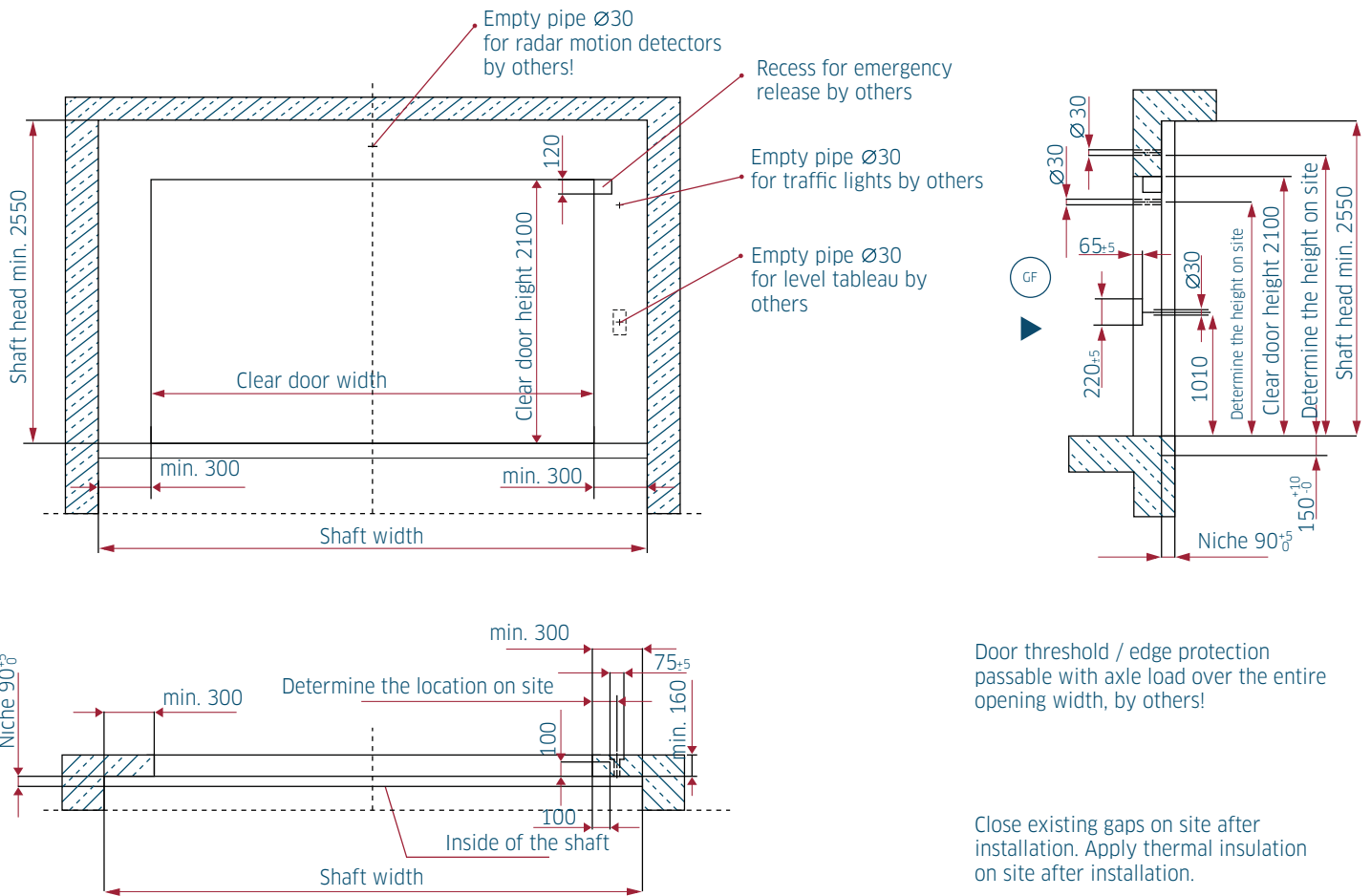

Door threshold / edge protection passable with axle load over the entire opening width, by others!

Close existing gaps on site after installation. Apply thermal insulation on site after installation.